

# 16" AUTOMATIC STRAINER

## In-Line Flow Type WSA

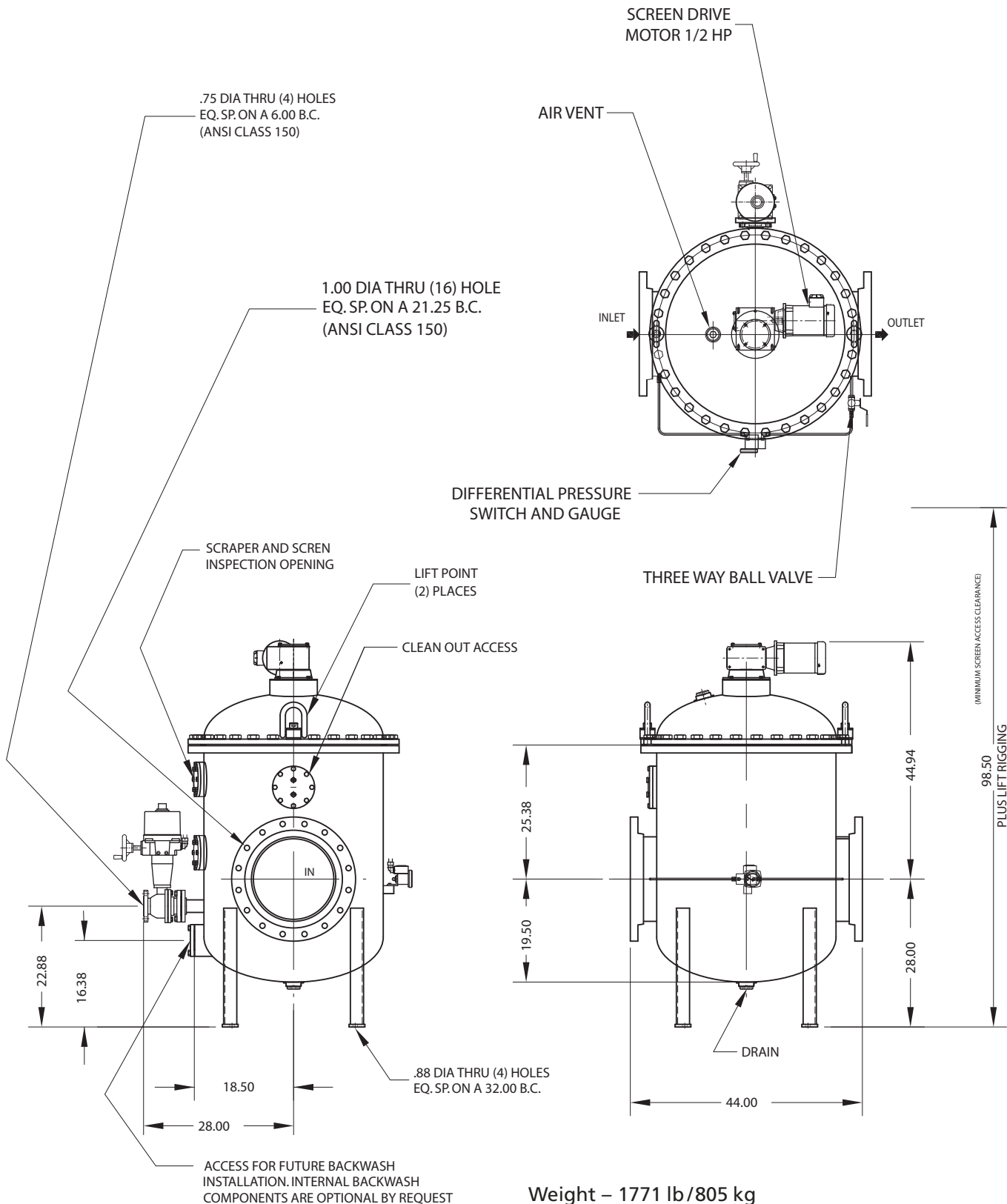

THESE DIMENSIONS ARE FOR REFERENCE ONLY. FOR INSTALLATION PURPOSES, REQUEST CERTIFIED DRAWINGS.