

16" AUTOMATIC STRAINER

In-Line Flow Type QA

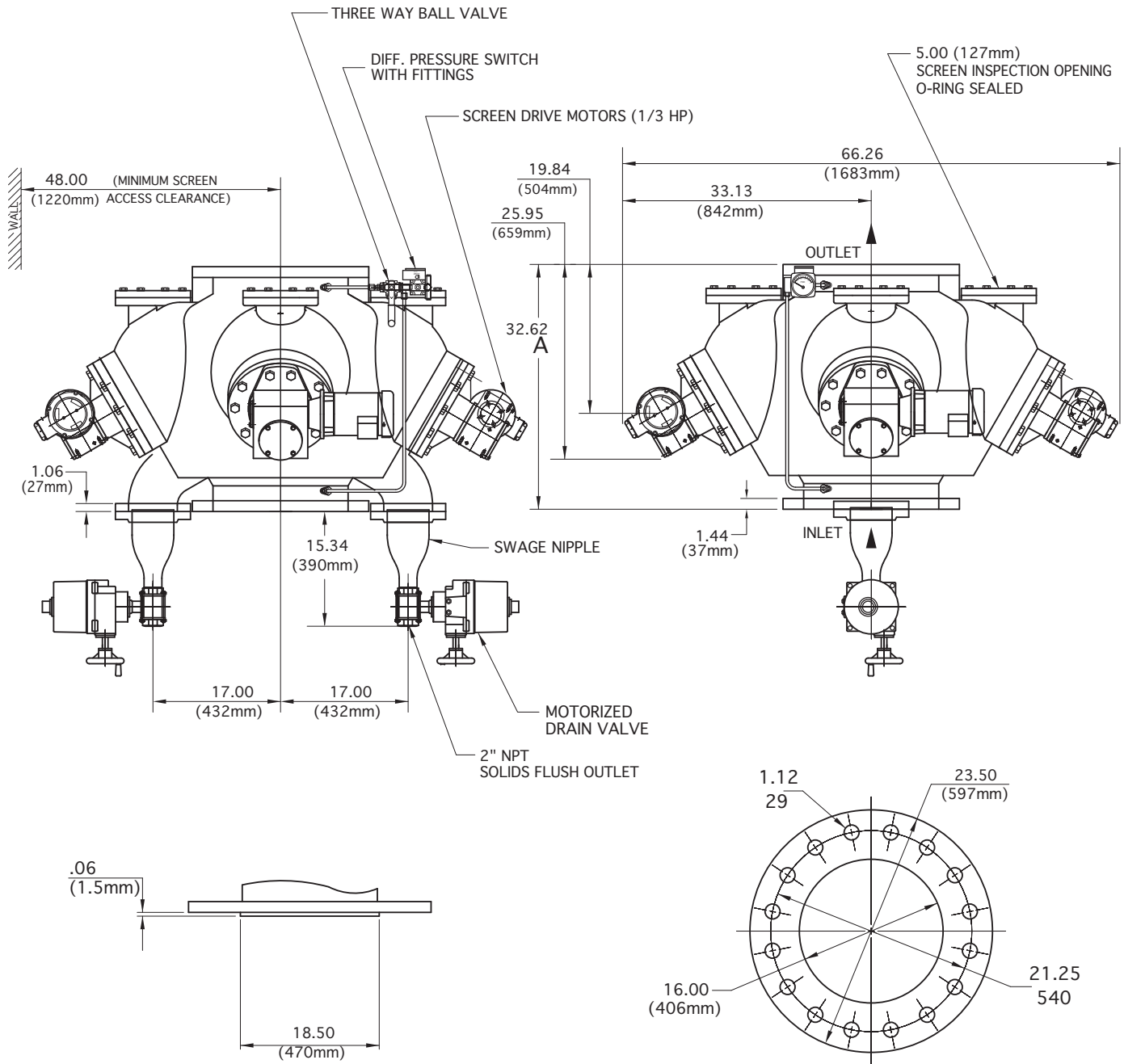

FOR ANSI CLASS 150

TOP & BOTTOM FLANGES

FLANGE SIZE		A	APPROX. WEIGHT
ANSI class 125 CAST IRON	INCH	32.62	4600 lb
	MM	829	2090 kg
ANSI class 150 CAST STEEL & STAINLESS STEEL	INCH	32.28	4830 lb
	MM	820	2190 kg

THESE DIMENSIONS ARE FOR REFERENCE ONLY. FOR INSTALLATION PURPOSES, REQUEST CERTIFIED DRAWINGS.